

Robotic Pool Cleaner W 20

EN

User Instructionsp. 1-11

FR

Mode d'emploi.....p. 12-22

IT

Istruzioni per l'usop. 23-33

ES

Instrucciones de Usop. 34-44

DE

Gebrauchsanweisungs. 45-55

PT

Manual de Instruçõesp. 56-66



—

—

—

—

EN

Robotic Pool Cleaner W 20

User Instructions

Contents

1. INTRODUCTION	2
2. SPECIFICATIONS	2
3. WARNINGS AND CAUTIONS	2
3.1 Warnings	2
3.2 Cautions	2
4. POOL CLEANER PARTS	3
5. USING THE POOL CLEANER	4
5.1 Setup	4
5.2 Putting the Pool Cleaner into the pool	5
5.3 Removing the Pool Cleaner from the pool	5
6. CLEANING THE FILTER BAG OR CARTRIDGES	6
6.1 Removing and cleaning the filter bag	6
6.2 Replacing the filter bag	7
6.3 Cleaning the filter cartridges	8
6.4 Cleaning the impeller	9
7. REMOTE CONTROL UNIT	10
8. OFFSEASON STORAGE	11
9. TROUBLESHOOTING	11
10. CADDY ASSEMBLY	67

Robotic Pool Cleaner W 20

User Instructions

1. INTRODUCTION

Thank you for purchasing a Maytronics Robotic Pool Cleaner.

We are sure that your Maytronics Robotic Pool Cleaner will provide you with reliable, convenient and cost effective pool cleaning. Its reliable filtration in all pool conditions and active brushing enhance maximum pool hygiene.

Robotic Pool Cleaners by Maytronics deliver advanced cleaning technology, long lasting performance and easy maintenance.

The Robotic Pool Cleaner is designed for shallow pools - minimum depth 0.20m/0.65ft.

2. SPECIFICATIONS

Motor protection: IP 68

Minimum depth: 0.20m/0.65ft

Maximum depth: 5m/16.4ft

Digital switch-mode power supply

- Input - 100-250 AC Volts
- 50-60 Hertz
- 180 Watt
- Output - <30 VDC
- IP 54

3. WARNINGS AND CAUTIONS

3.1 Warnings



- Use the originally supplied power supply only
- Ensure the electrical outlet is protected by a ground fault interrupter (GFI) or an earth leakage interrupter (ELI)
- Keep the power supply out of standing water
- Position the power supply at least 3m/10ft away from the edge of the pool
- Do not enter the pool while the Pool Cleaner is working
- Unplug the power supply before servicing

3.2 Cautions

When not in use store the Pool Cleaner on the Caddy in a shaded area.

Use the Pool Cleaner in the following water conditions only:

Chlorine	Max 4 ppm
pH	7.0 - 7.8
Temperature	6°-34°C / 43°-93°F
NaCl	Maximum = 5000 ppm

4. POOL CLEANER PARTS

► Robotic Pool Cleaner W 20

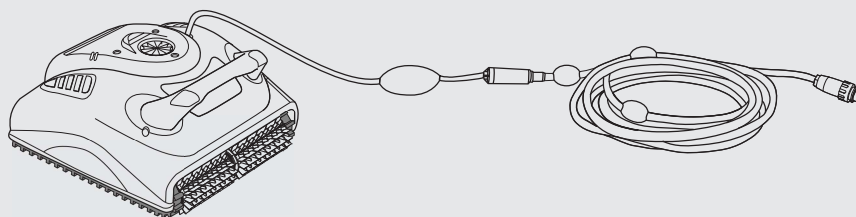

► Filtration

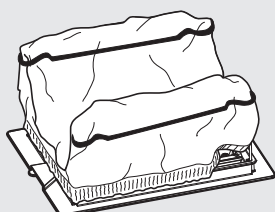

Bottom lid and filter Bag

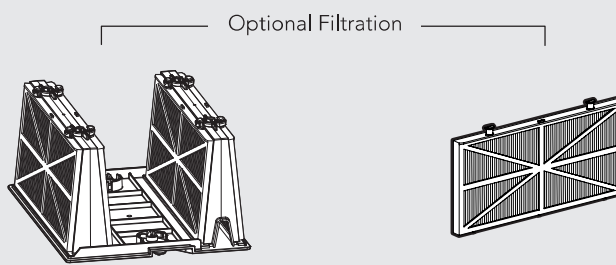

Cartridge with net filters (x4)

Ultra-fine filter (x4)

► Brush

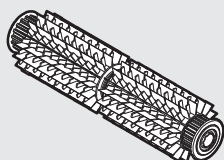

PVC Brush
Ideal for all pool surfaces

► Remote Control

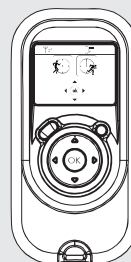

► Power Supply

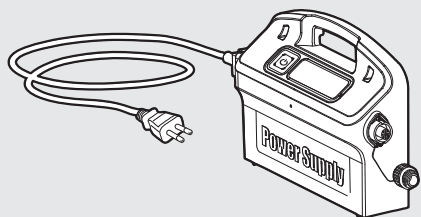

► Caddy

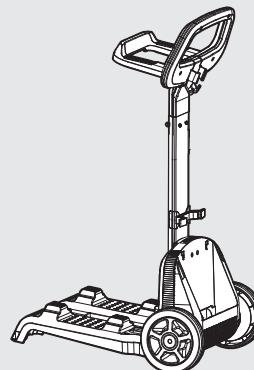

5. USING THE POOL CLEANER

The Pool Cleaner is very easy to use. Just follow the simple steps to get started, and your Pool Cleaner is ready to go.

5.1 Setup

Before using the Pool Cleaner for the first time perform the following steps:

Unwind the cable and stretch it out completely so that it has no kinks.

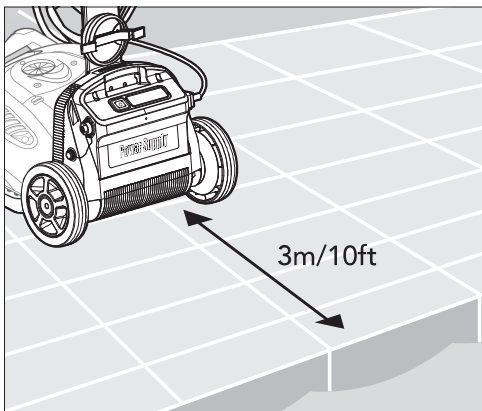
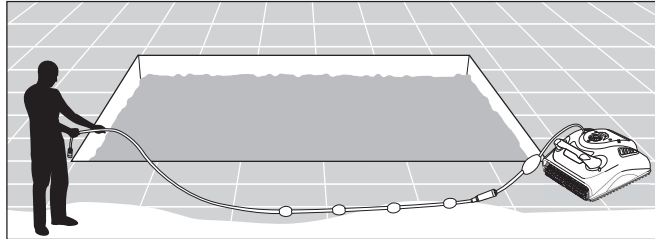

Position the power supply so that it is approximately in the middle of the long side of the pool at a distance of 3m/10ft.

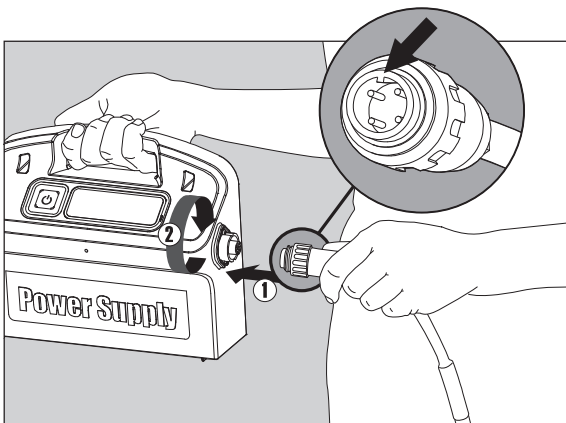

Attach the floating cable to the power supply by inserting it with the notch on the connector (1) lined up with the groove in the socket on the power supply and turning clockwise (2).

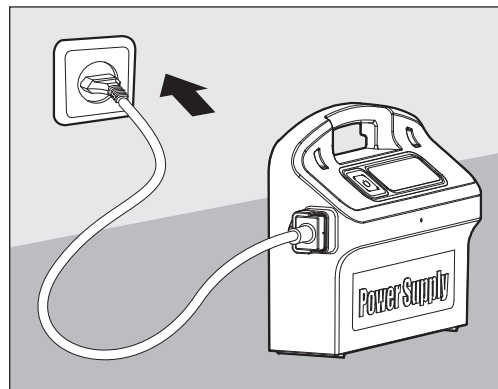

Plug in the power supply and leave it in the OFF position.

5.2 Putting the Pool Cleaner into the pool

Holding the Pool Cleaner upside down in the water, gently rock it back and forth with your fingers holding the plastic doors on the bottom lid open to release trapped air. Continue until no more bubbles are released.

Release the Pool Cleaner and let it sink to the floor of the pool.

Make sure that the floating cable is free of any obstructions.

To avoid kinks in the floating cable, place approximately enough cable in the water for the Pool Cleaner to reach the farthest corner of the pool.

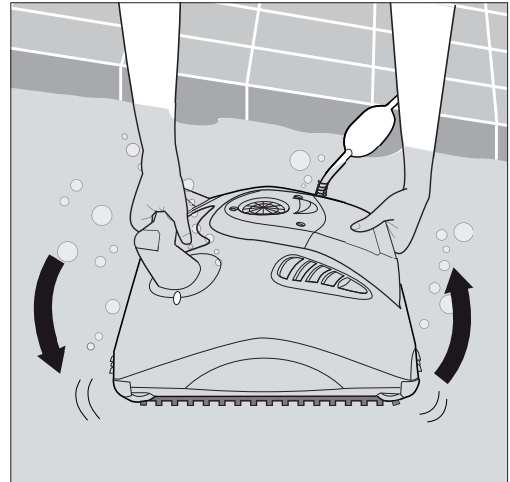

Turn the power supply ON.

The Pool Cleaner will now operate until it has reached the end of the cleaning cycle.

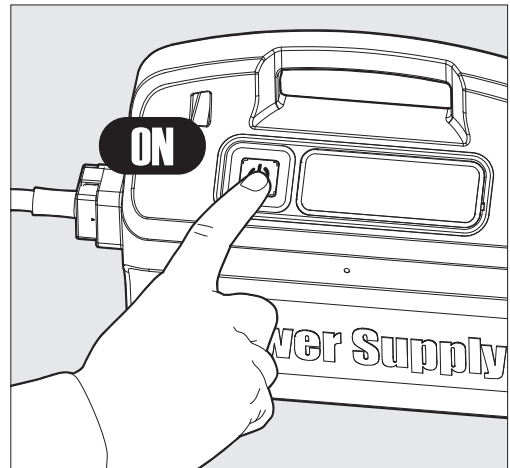

5.3 Removing the Pool Cleaner from the pool

 Turn OFF and unplug the power supply.

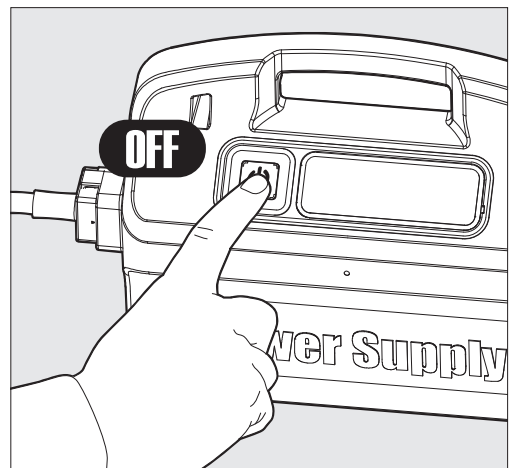

Using the floating cable, bring the Pool Cleaner to the pool's edge.
Using the handle, remove the Pool Cleaner from the pool.

 **DO NOT PULL THE POOL CLEANER FROM THE POOL USING THE CABLE.**

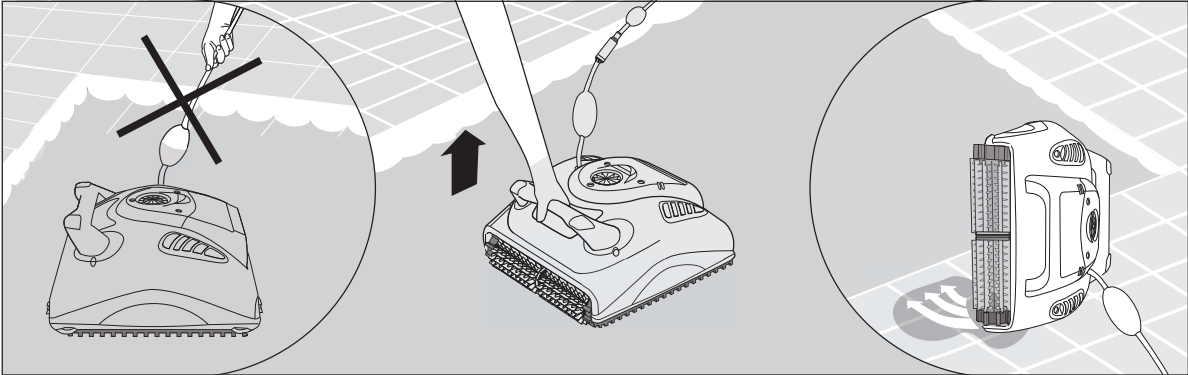

Place the Pool Cleaner on the edge of the pool and let the water drain out.

6. CLEANING THE FILTER BAG OR CARTRIDGES

Depending on the model, your Pool Cleaner may be equipped with a filter bag or cartridge. It is recommended to clean the filter bag or cartridge after each cleaning cycle.

6.1 Removing and cleaning the filter bag

 **Unplug the power supply.**

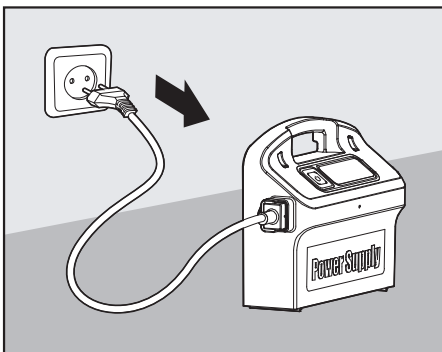

Turn the Pool Cleaner upside-down.
Open the bottom lid.

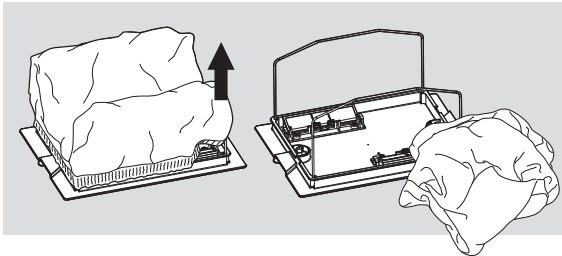
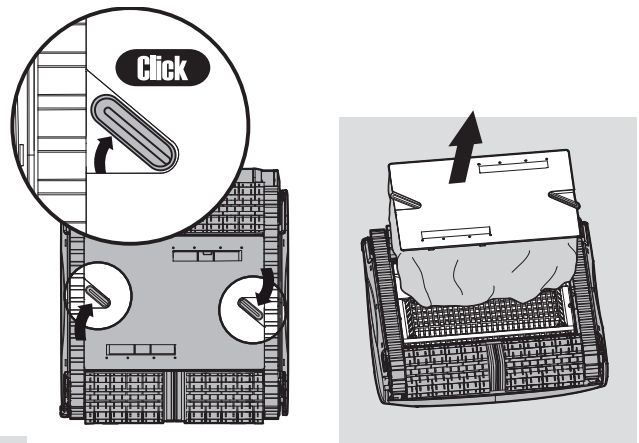

Remove the filter bag.

Clean the filter bag with a hose.
We recommend that you periodically wash the
filter bag in a washing machine using the gentle
cycle program.
Periodically clean the brushes with a hose.

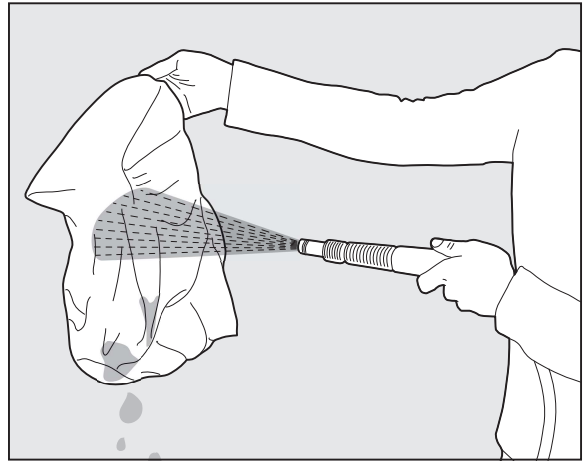

6.2 Replacing the filter bag

Put the filter bag over
the frame so that the
strap is in the middle
of the shortest side.
Make sure that filter bag
is positioned properly
on the frame.

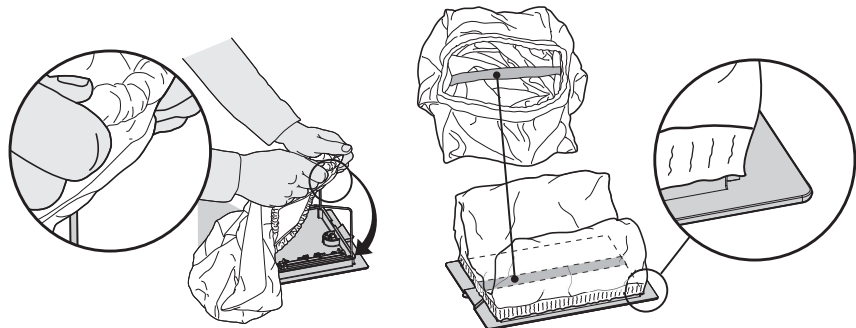

6.3 Cleaning the filter cartridges

Note: Don't let the filter cartridges dry out before cleaning.

 Unplug the power supply.

With the Pool Cleaner upside down open the bottom lid and pull it out.

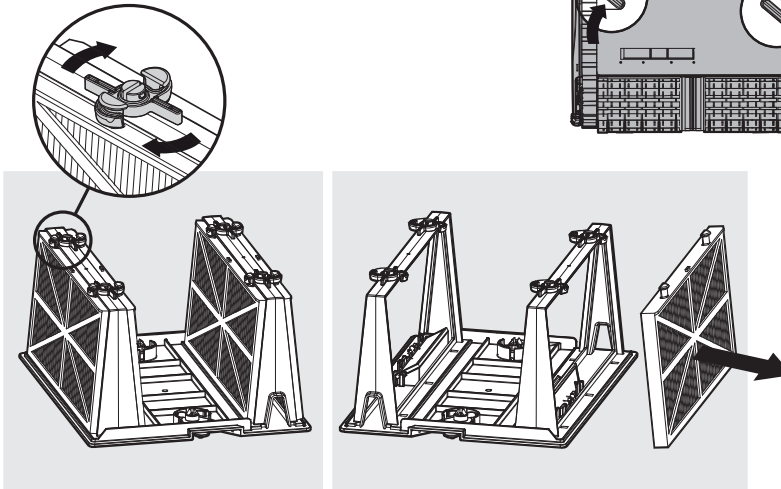
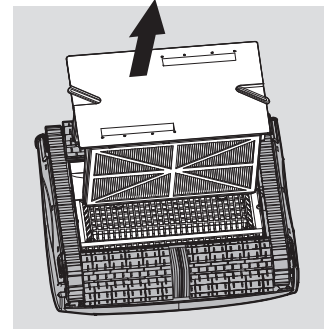
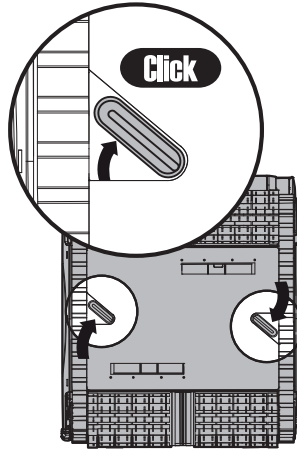

Open the clips and remove the filter.

Clean the filters with a hose.

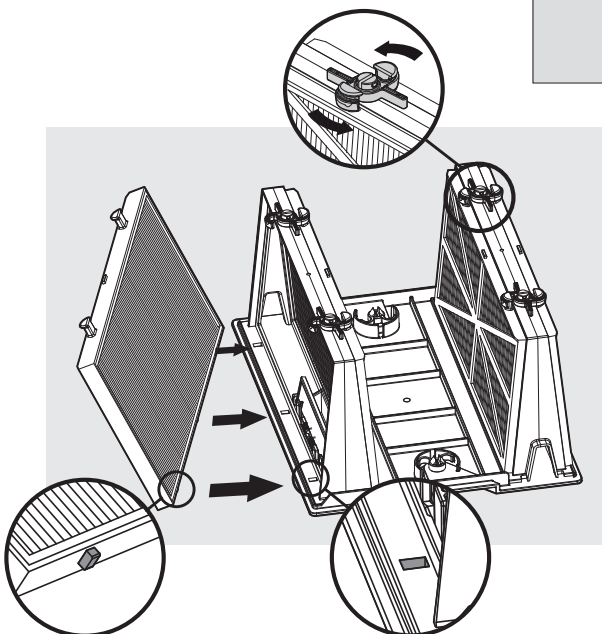
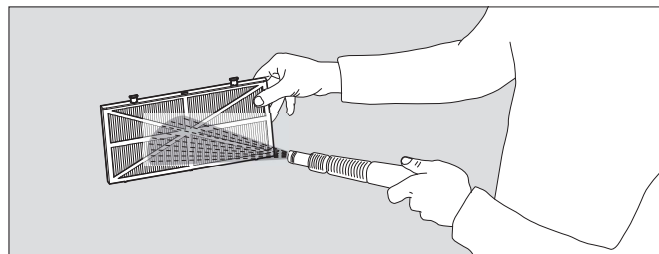

Insert the filters with the plastic backing facing out.
Insert the cartridge unit.

6.4 Cleaning the impeller

If you notice debris trapped in the impeller open the impeller and remove the debris.

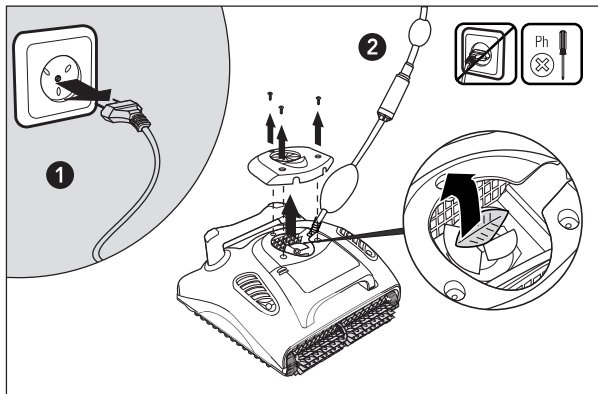

 **Unplug the power supply.**

Using a screwdriver, remove the screws on the impeller cover and remove it.

Clear any debris that may be in the impeller.

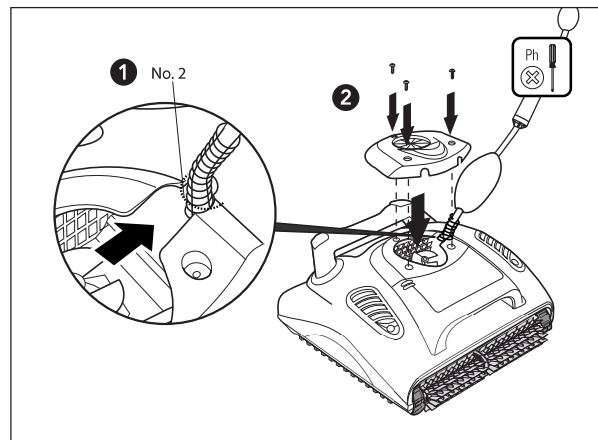

Replace the screws.

7. REMOTE CONTROL UNIT

Maytronics Cycle Selector Remote Control

The Remote Control Unit offers two operation modes - Automatic mode and Manual direction mode. In Automatic cleaning mode, the fast or regular cleaning cycle can be selected. In Manual direction mode, the pool cleaner direction can be controlled manually.

The Control Panel of the Remote Control Unit

Radio reception meter -

If no black lines show you should move closer to the power supply unit

Regular cleaning cycle

Manual/Automatic mode select button

Battery level meter -

When the icon flashes, change the batteries

Fast cleaning cycle

Manual control indicator

ON/OFF button

Set/OK button

Direction control arrows

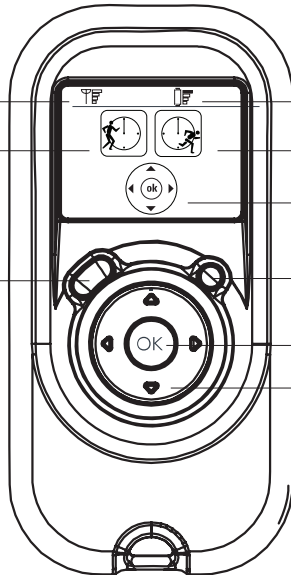

Manually controlling the direction of the Pool Cleaner

1. Press the ON/OFF button once - The Remote Control Unit will start-up in Manual direction control mode.
2. To manually control the direction of the pool cleaner, utilise the Direction control arrows.

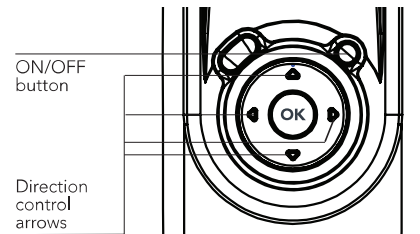

Exiting Manual Direction Control Mode and set the Automatic Mode

To exit the Manual direction control mode press the Manual/Automatic Selection button ONCE only.

The Digital screen will light up and the two (regular/fast) icons will show up.

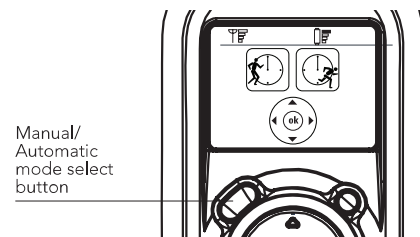

To choose regular or fast cleaning cycle use the right or left arrows. When you reach the required function press the Set/OK button.

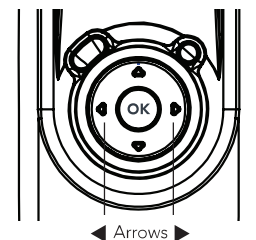

Note: After 2 minutes, if no button is pressed the Remote Control Unit will shut-down and the Pool cleaner will continue to work as started.

8. OFFSEASON STORAGE

If the Pool Cleaner will not be in use for an extended period, perform the following storage steps:

- Disconnect the Pool Cleaner from mains
- Make sure that no water is left in the Pool Cleaner
- Thoroughly clean the filter bag or cartridges and insert in place
- Roll up the cable so that it has no kinks and place on the Caddy
- Store the Pool Cleaner upright on the Caddy or simply upside down in a protected area out of direct sun/rain/snow at a temperature of between 5°-45°C/41°-113°F

9. TROUBLESHOOTING

Before contacting your W 20 distributor please read through this guide.

Symptom	Solution
Cable twisting or cable coils up	Check for any obstruction in the pool
	Remove excess cable from the pool
	Make sure filter bag / filter cartridge is clean
	Straighten cable and lay it in the sun periodically
W 20 is moving in circles or does not reach all pool areas	Check for foreign objects in moving parts
	Make sure filter bag / filter cartridge is clean and well mounted and that the filter doors are closed
	Make sure that there is enough cable laid out to cover the whole pool
	Before using the W 20 at the beginning of the season you should brush any algae from the floor and walls of the pool
Remote control is not working	Check if the batteries need replacing
Motor is not working	Check if the impeller is blocked
	Check if the drive system is blocked
	Electrical problem (power supply), check power source. If power source is in order, please contact your W 20 distributor

Additional troubleshooting is available at our Website: www.maytronics.com